

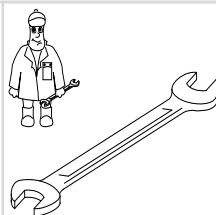

Gebr. Becker GmbH  
Hölker Feld 29-31  
D-42279 Wuppertal

Wartung  
Maintenance  
Entretien  
Manutenzione  
Mantenimiento



	Pos.	Menge <sup>2)</sup> Quantity Quantité Quantità Cantidad	Bestell-Nr. Ident No. No. Identification No. Identificazione No. de pedido	Bezeichnung Description Designation Designazione Descripción
VT 4.25	24	SATZ (KIT)	901349 00007	Schieber, Rotor Vane, Palette, Empujador
	72	1	909505 00000	Filterpatrone, Filter cartridge, Cartouche Filtrante, Cartuccia filtro, Cartucho de filtro
VT 4.40	24	SATZ (KIT)	901352 00007	Schieber, Rotor Vane, Palette, Empujador
	72	1	909505 00000	Filterpatrone, Filter cartridge, Cartouche Filtrante, Cartuccia filtro, Cartucho de filtro

<sup>2)</sup> erforderliche Bestellmenge / necessary order quantity / quantité nécessaire / quantità di ordinazione necessari / cantidad necesario



Ersatzteilliste  
Spare parts list  
Liste de pièces de rechange  
Listino pezzi di ricambio  
Lista de piezas de recambio  
Lista de peças sobresselentes  
Reserveonderdelenlijst  
Reservedelsliste  
Reservdelslista

Reservedelsliste  
Varaosaluettelo  
Wykaz części zamiennych  
Seznam náhradních dílů  
Tartalékalkatrész lista  
Κατάλογος ανταλλακτικών  
Перечень запасных частей  
备用零件目录  
スペアパーツリスト

VT 4.25  
VT 4.40



28007500000 03/2006

## Index-A

**SERVICE**

**BECKER**  
D-42279 Wuppertal  
www.becker-international.com

CE

type **VT 4.25-XX**

frequency \_\_\_\_\_ Hz

speed \_\_\_\_\_ min<sup>-1</sup>

power required \_\_\_\_\_ kW

inlet capacity \_\_\_\_\_ m<sup>3</sup>/h

max. vacuum \_\_\_\_\_ mbar

year \_\_\_\_\_

Index Option

**(D) Service:**

**Tel:** +49 (0)202 697-171

**Fax:** +49 (0)202 64 44 74

**E-Mail:** info@becker-international.com

[www.becker-international.com](http://www.becker-international.com)



VT 4.25

Pos.	Bestell Nr.	Beschreibung	
15	020000 16400	KOLBEN	
16	016800 16500	SPANNSCHEIBE	
17	911012 00000	STAR-TOLERANZRING	
18	949203 00000	ZAHNSCHEIBE	
19	945320 00000	INNENSECHSKANTSCHRAUBE	
21	000101 16400	GEHÄUSE	
23	945320 00000	INNENSECHSKANTSCHRAUBE	
24	901349 00007	<b>SCHIEBER, KOHLE (SATZ) <sup>1)</sup></b>	
25	952009 00000	SPANNHÜLSE	
28	000710 16500	SEITENDECKEL	
29	945373 00000	INNENSECHSKANTSCHRAUBE	
30	008900 16500	DICHTUNG	
46	502301 16400	VENTILATOR MIT NABE	
48	947713 00000	PASSFEDER	
49	949454 00000	U-SCHEIBE	
50	901804 00000	WELLENENDSCHRAUBE TUFLOK	
61	004803 27600	FILTERDECKEL	
67	009000 16300	ANPRESSFEDER	
72	909505 00000	<b>FILTERPATRONE (1x) <sup>1)</sup></b>	
76	945373 00000	INNENSECHSKANTSCHRAUBE	
77	948021 00000	DICHTRING	
78	913161 00000	O-RING	
83	006801 27500	GERÄTEHAUBE (INDEX <b>A</b> )	
83	006805 27500	GERÄTEHAUBE (INDEX <b>B</b> )	
85	951920 00000	GUMMIFORMTEIL	
88	006802 27600	GERÄTEHAUBE	
89	741365 00000	GUMMIPUFFER	
90	945318 00000	INNENSECHSKANTSCHRAUBE	
91	951922 00000	GUMMIFORMTEIL	
92	964110 00000	KANTENSCHUTZ	
94	015100 27600	FUSS	
95	951921 00000	GUMMIFORMTEIL	
96	068000 27600	DISTANZSTÜCK	
97	945328 00000	INNENSECHSKANTSCHRAUBE	
98	949451 00000	UNTERLEGSCHNEIBE	
101	833903 99597	VENTILTELLER	
102	951906 00000	KABELTÜLLE	
103	068002 16500	DISTANZROHR	
104	548800 16300	RINGSCHRAUBE	
124	736001 99613	VAKUUMREGULIERVENTIL	
127	727502 06000	ABBLASEVENTIL	

<sup>1)</sup> erforderliche Bestellmenge / Wartung

**VT 4.25** (1~) Ausführung - Einphasenwechselstrom

**VT 4.25/0-06** (3~) Ausführung ohne Filterung / Drehstrom

Abweichende Positionen zum Standardgerät - siehe Anhang (Zeichnungsrückseite)

OPTIONAL



VT 4.40

Pos.	Bestell Nr.	Beschreibung	
15	020000 16500	KOLBEN	
16	016800 16500	SPANNSCHEIBE	
17	911008 00000	STAR-TOLERANZRING	
18	949203 00000	ZAHNSCHEIBE	
19	945320 00000	INNENSECHSKANTSCHRAUBE	
21	000102 16500	GEHÄUSE	
23	945322 00000	INNENSECHSKANTSCHRAUBE	
24	901352 00007	<b>SCHIEBER, KOHLE (SATZ) <sup>1)</sup></b>	
25	952009 00000	SPANNHÜLSE	
28	000710 16500	SEITENDECKEL	
29	945374 00000	INNENSECHSKANTSCHRAUBE	
30	008900 16500	DICHTUNG	
46	902300 26200	VENTILATOR MIT NABE	
48	947713 00000	PASSFEDER	
49	949454 00000	U-SCHEIBE	
50	901804 00000	WELLENENDSCHRAUBE TUFLOK	
61	004803 27600	FILTERDECKEL	
67	009000 16300	ANPRESSFEDER	
72	909505 00000	<b>FILTERPATRONE (1x) <sup>1)</sup></b>	
76	945373 00000	INNENSECHSKANTSCHRAUBE	
77	948021 00000	DICHTRING	
78	913161 00000	O-RING	
83	006801 27600	GERÄTEHAUBE	
85	951920 00000	GUMMIFORMTEIL	
88	006802 27600	GERÄTEHAUBE	
89	741365 00000	GUMMIPUFFER	
90	945318 00000	INNENSECHSKANTSCHRAUBE	
91	951922 00000	GUMMIFORMTEIL	
92	964109 00000	KANTENSCHUTZ	
94	015100 27600	FUSS	
95	951921 00000	GUMMIFORMTEIL	
96	068000 27600	DISTANZSTÜCK	
97	945328 00000	INNENSECHSKANTSCHRAUBE	
98	949451 00000	UNTERLEGSCHNEIBE	
101	833903 99597	VENTILTELLER	
102	951906 00000	KABELTÜLLE	
103	068002 16500	DISTANZROHR	
104	548800 16300	RINGSCHRAUBE	
124	736001 99613	VAKUUMREGULIERVENTIL	
127	727502 06000	ABBLASEVENTIL	

<sup>1)</sup> erforderliche Bestellmenge / Wartung

**VT 4.40** (1~) Ausführung - Einphasenwechselstrom

Abweichende Positionen zum Standardgerät - siehe Anhang (Zeichnungsrückseite)

OPTIONAL



VT 4.25

Pos.	Ident No.	Description
15	020000 16400	ROTOR
16	016800 16500	CLAMPING DISC
17	911012 00000	STAR-TOLERANCE-RING
18	949203 00000	TOOTHED SPRING WASHER
19	945320 00000	SOCKET HEAD SCREW
21	000101 16400	PUMP BODY
23	945320 00000	SOCKET HEAD SCREW
24	901349 00007	<b>CARBON VANES (KIT) <sup>1)</sup></b>
25	952009 00000	LOCATING PIN
28	000710 16500	LID
29	945373 00000	SOCKET HEAD SCREW
30	008900 16500	GASKET
46	502301 16400	FAN
48	947713 00000	KEY
49	949454 00000	WASHER
50	901804 00000	SHAFT END BOLT
61	004803 27600	FILTER COVER
67	009000 16300	BLADE SPRING
72	909505 00000	<b>FILTER CARTRIDGE (1x) <sup>1)</sup></b>
76	945373 00000	SOCKET HEAD SCREW
77	948021 00000	SEALING RING
78	913161 00000	O-RING
83	006801 27500	PROTECTING HOOD (INDEX A)
83	006805 27500	PROTECTING HOOD (INDEX B)
85	951920 00000	RUBBER ELEMENT
88	006802 27600	PROTECTING HOOD (FRONT)
89	741365 00000	RUBBER BUFFER
90	945318 00000	SOCKET HEAD SCREW
91	951922 00000	RUBBER ELEMENT
92	964110 00000	EDGE PROTECTION
94	015100 27600	FOOT
95	951921 00000	RUBBER ELEMENT
96	068000 27600	SPACING COLLAR
97	945328 00000	SOCKET HEAD SCREW
98	949451 00000	WASHER
101	833903 99597	DISC
102	951906 00000	RUBBER BUSHING
103	068002 16500	SPACER TUBE
104	548800 16300	EYE SCREW
124	736001 99613	VACUUM REGULATING VALVE
127	727502 06000	BLOW-OFF VALVE

<sup>1)</sup> necessary order quantity / maintenance

**VT 4.25** (1~) Design - single-phase AC

**VT 4.25/0-06** (3~) Design - without filter / three phase AC

Items different from standard appliance see appendix (back of drawing)



VT 4.40

Pos.	Ident No.	Description
15	020000 16500	ROTOR
16	016800 16500	CLAMPING DISC
17	911008 00000	STAR-TOLERANCE-RING
18	949203 00000	TOOTHED SPRING WASHER
19	945320 00000	SOCKET HEAD SCREW
21	000102 16500	PUMP BODY
23	945322 00000	SOCKET HEAD SCREW
24	901352 00007	<b>CARBON VANES (KIT) <sup>1)</sup></b>
25	952009 00000	LOCATING PIN
28	000710 16500	LID
29	945374 00000	SOCKET HEAD SCREW
30	008900 16500	GASKET
46	902300 26200	FAN
48	947713 00000	KEY
49	949454 00000	WASHER
50	901804 00000	SHAFT END BOLT
61	004803 27600	FILTER COVER
67	009000 16300	BLADE SPRING
72	909505 00000	<b>FILTER CARTRIDGE (1x) <sup>1)</sup></b>
76	945373 00000	SOCKET HEAD SCREW
77	948021 00000	SEALING RING
78	913161 00000	O-RING
83	006801 27600	PROTECTING HOOD
85	951920 00000	RUBBER ELEMENT
88	006802 27600	PROTECTING HOOD (FRONT)
89	741365 00000	RUBBER BUFFER
90	945318 00000	SOCKET HEAD SCREW
91	951922 00000	RUBBER ELEMENT
92	964109 00000	EDGE PROTECTION
94	015100 27600	FOOT
95	951921 00000	RUBBER ELEMENT
96	068000 27600	SPACING COLLAR
97	945328 00000	SOCKET HEAD SCREW
98	949451 00000	WASHER
101	833903 99597	DISC
102	951906 00000	RUBBER BUSHING
103	068002 16500	SPACER TUBE
104	548800 16300	EYE SCREW
124	736001 99613	VACUUM REGULATING VALVE
127	727502 06000	BLOW-OFF VALVE

<sup>1)</sup> necessary order quantity / maintenance

**VT 4.40** (1~) Design - single-phase AC

Items different from standard appliance see appendix (back of drawing)



OPTIONAL

OPTIONAL



VT 4.25

Pos.	No. Identification	Designation
15	020000 16400	PISTON
16	016800 16500	DISQUE DE SERRAGE
17	911012 00000	BAGUE STAR
18	949203 00000	DENT DISQUE
19	945320 00000	VIS HEXAGONALE INTERNE
21	000101 16400	CORP DE POMPE
23	945320 00000	VIS HEXAGONALE INTERNE
24	901349 00007	<b>PALETTE DE CHARBON (KIT) <sup>1)</sup></b>
25	952009 00000	DOVILLE DE ETRAGE
28	000710 16500	COUVERCLE
29	945373 00000	VIS HEXAGONALE INTERNE
30	008900 16500	JOINT
46	502301 16400	VENTILATEUR
48	947713 00000	CLAVETTE
49	949454 00000	RONDELLE
50	901804 00000	VIS BOUT D'ARBRE
61	004803 27600	COUVERCLE DU FILTRE
67	009000 16300	RESSORT-JAME
72	909505 00000	<b>CARTOUCHE FILTRANTE (1x) <sup>1)</sup></b>
76	945373 00000	VIS HEXAGONALE INTERNE
77	948021 00000	JOINT
78	913161 00000	ANNEAU-O
83	006801 27500	CARTER PROTECTEUR (INDEX <b>A</b> )
83	006805 27500	CARTER PROTECTEUR (INDEX <b>B</b> )
85	951920 00000	ELEMENT EN CAOUTCHOUC
88	006802 27600	CARTER PROTECTEUR
89	741365 00000	AMORTISSEUR EN CAOUTCHOUC
90	945318 00000	VIS HEXAGONALE INTERNE
91	951922 00000	ELEMENT EN CAOUTCHOUC
92	964110 00000	PROTECTION D'ARETE
94	015100 27600	PIED
95	951921 00000	ELEMENT EN CAOUTCHOUC
96	068000 27600	DONILLE D'ECARMENT
97	945328 00000	VIS HEXAGONALE INTERNE
98	949451 00000	RONDELLE
101	833903 99597	PLATEAU DE SOUPE
102	951906 00000	PROTECTION EN CAOUTCHOUC
103	068002 16500	TUBE D'ECARTEMENT
104	548800 16300	PITON
124	736001 99613	SOUPE REGLAGE VIDE
127	727502 06000	SILENCIEUX

<sup>1)</sup> quantité nécessaire / entretien

VT 4.25 (1~) Fabrication - AC monophasé

VT 4.25/0-06 (3~) Fabrication sans filtre / AC triphasé

Articles divergents vis-à-vis de l'appareil standard, voir annexe (dos du dessin / du plan)

EN OPTION



VT 4.40

Pos.	No. Identification	Designation
15	020000 16500	PISTON
16	016800 16500	DISQUE DE SERRAGE
17	911008 00000	BAGUE STAR
18	949203 00000	DENT DISQUE
19	945320 00000	VIS HEXAGONALE INTERNE
21	000102 16500	CORP DE POMPE
23	945322 00000	VIS HEXAGONALE INTERNE
24	901352 00007	<b>PALETTE DE CHARBON (KIT) <sup>1)</sup></b>
25	952009 00000	DOVILLE DE ETRAGE
28	000710 16500	COUVERCLE
29	945374 00000	VIS HEXAGONALE INTERNE
30	008900 16500	JOINT
46	902300 26200	VENTILATEUR
48	947713 00000	CLAVETTE
49	949454 00000	RONDELLE
50	901804 00000	VIS BOUT D'ARBRE
61	004803 27600	COUVERCLE DU FILTRE
67	009000 16300	RESSORT-JAME
72	909505 00000	<b>CARTOUCHE FILTRANTE (1x) <sup>1)</sup></b>
76	945373 00000	VIS HEXAGONALE INTERNE
77	948021 00000	JOINT
78	913161 00000	ANNEAU-O
83	006801 27600	CARTER PROTECTEUR
85	951920 00000	ELEMENT EN CAOUTCHOUC
88	006802 27600	CARTER PROTECTEUR
89	741365 00000	AMORTISSEUR EN CAOUTCHOUC
90	945318 00000	VIS HEXAGONALE INTERNE
91	951922 00000	ELEMENT EN CAOUTCHOUC
92	964109 00000	PROTECTION D'ARETE
94	015100 27600	PIED
95	951921 00000	ELEMENT EN CAOUTCHOUC
96	068000 27600	DONILLE D'ECARMENT
97	945328 00000	VIS HEXAGONALE INTERNE
98	949451 00000	RONDELLE
101	833903 99597	PLATEAU DE SOUPE
102	951906 00000	PROTECTION EN CAOUTCHOUC
103	068002 16500	TUBE D'ECARTEMENT
104	548800 16300	PITON
124	736001 99613	SOUPE REGLAGE VIDE
127	727502 06000	SILENCIEUX

<sup>1)</sup> quantité nécessaire / entretien

VT 4.40 (1~) Fabrication - AC monophasé

Articles divergents vis-à-vis de l'appareil standard, voir annexe (dos du dessin / du plan)

EN OPTION



VT 4.25

Pos.	No. Identificazione	Designazione
15	020000 16400	ROTORE
16	016800 16500	DISCO DI FISSAGGIO
17	911012 00000	STAR-ANELLO TOLLERANZA
18	949203 00000	DISCO A DENTE
19	945320 00000	VITE ESAGONALE INTERNA
21	000101 16400	CARCASSA
23	945320 00000	VITE ESAGONALE INTERNA
24	901349 00007	<b>PALETTE DI CHARBONE (KIT) <sup>1)</sup></b>
25	952009 00000	SPINE DI RISCONTRO
28	000710 16500	COPERCHIO
29	945373 00000	VITE ESAGONALE INTERNA
30	008900 16500	GUARNIZIONE
46	502301 16400	VENTILATORE
48	947713 00000	CHIAVETTA
49	949454 00000	RONDELLA
50	901804 00000	VITE DI CHIUSURA ALBERO
61	004803 27600	COPERCHIO FILTRO
67	009000 16300	MOLLA
72	909505 00000	<b>CARTUCCIA FILTRO (1x) <sup>1)</sup></b>
76	945373 00000	VITE ESAGONALE INTERNA
77	948021 00000	ANELLO GUARNIZIONE
78	913161 00000	ANELLO-O
83	006801 27500	CAPOTO DI PRTEZIONE (INDEX A)
83	006805 27500	CAPOTO DI PRTEZIONE (INDEX B)
85	951920 00000	ELEMENTO IN GOMMA
88	006802 27600	CARTER DI PROTEZIONE
89	741365 00000	AMMORTIZZATORE IN GOMMA
90	945318 00000	VITE ESAGONALE INTERNA
91	951922 00000	ELEMENTO IN GOMMA
92	964110 00000	LISTELLO DI PROTEZIONE
94	015100 27600	PIEDE
95	951921 00000	ELEMENTO IN GOMMA
96	068000 27600	BOCCOLA DISTANZIATRICE
97	945328 00000	VITE ESAGONALE INTERNA
98	949451 00000	RONDELLA
101	833903 99597	PIATELLO DELLA VALVOLA
102	951906 00000	PROTEZIONE IN GOMMA
103	068002 16500	TUBO DISTANZA
104	548800 16300	GANCIO
124	736001 99613	VALVOLA REGOLAZIONE VUOTO
127	727502 06000	SILENZIATORE

<sup>1)</sup> quantità di ordinazione necessari / manutenzione

VT 4.25 (1~) Modello - AC monofase

VT 4.25/0-06 (3~) Modello senza filtro / AC trifase

Vedere allegato (retro del disegno) per le posizioni divergenti dall'apparecchio standard

OPTIONALE



VT 4.40

Pos.	No. Identificazione	Designazione
15	020000 16500	ROTORE
16	016800 16500	DISCO DI FISSAGGIO
17	911008 00000	STAR-ANELLO TOLLERANZA
18	949203 00000	DISCO A DENTE
19	945320 00000	VITE ESAGONALE INTERNA
21	000102 16500	CARCASSA
23	945322 00000	VITE ESAGONALE INTERNA
24	901352 00007	<b>PALETTE DI CHARBONE (KIT) <sup>1)</sup></b>
25	952009 00000	SPINE DI RISCONTRO
28	000710 16500	COPERCHIO
29	945374 00000	VITE ESAGONALE INTERNA
30	008900 16500	GUARNIZIONE
46	902300 26200	VENTILATORE
48	947713 00000	CHIAVETTA
49	949454 00000	RONDELLA
50	901804 00000	VITE DI CHIUSURA ALBERO
61	004803 27600	COPERCHIO FILTRO
67	009000 16300	MOLLA
72	909505 00000	<b>CARTUCCIA FILTRO (1x) <sup>1)</sup></b>
76	945373 00000	VITE ESAGONALE INTERNA
77	948021 00000	ANELLO GUARNIZIONE
78	913161 00000	ANELLO-O
83	006801 27600	CAPOTO DI PRTEZIONE
85	951920 00000	ELEMENTO IN GOMMA
88	006802 27600	CARTER DI PROTEZIONE
89	741365 00000	AMMORTIZZATORE IN GOMMA
90	945318 00000	VITE ESAGONALE INTERNA
91	951922 00000	ELEMENTO IN GOMMA
92	964109 00000	LISTELLO DI PROTEZIONE
94	015100 27600	PIEDE
95	951921 00000	ELEMENTO IN GOMMA
96	068000 27600	BOCCOLA DISTANZIATRICE
97	945328 00000	VITE ESAGONALE INTERNA
98	949451 00000	RONDELLA
101	833903 99597	PIATELLO DELLA VALVOLA
102	951906 00000	PROTEZIONE IN GOMMA
103	068002 16500	TUBO DISTANZA
104	548800 16300	GANCIO
124	736001 99613	VALVOLA REGOLAZIONE VUOTO
127	727502 06000	SILENZIATORE

<sup>1)</sup> quantità di ordinazione necessari / manutenzione

VT 4.40 (1~) Modello - AC monofase

Vedere allegato (retro del disegno) per le posizioni divergenti dall'apparecchio standard

OPTIONALE



VT 4.25

Pos.	No. De pedido	Descripción	
15	020000 16400	ÉMBOLO	
16	016800 16500	ARANDELA TENSORA	
17	911012 00000	ANILLO DE TOLERANCIA STAR	
18	949203 00000	POLEA DENTADA	
19	945320 00000	TORNILLO HEXAGONAL INTERIOR	
21	000101 16400	CARCASA	
23	945320 00000	TORNILLO HEXAGONAL INTERIOR	
24	901349 00007	<b>EMPUJADOR DE CARBÓN (KIT)<sup>1)</sup></b>	
25	952009 00000	CASQUILLO TENSOR	
28	000710 16500	TAPA LATERAL	
29	945373 00000	TORNILLO HEXAGONAL INTERIOR	
30	008900 16500	JUNTA	
46	502301 16400	VENTILADOR CON CUBO	
48	947713 00000	LENGÜETA DE AJUSTE	
49	949454 00000	ARANDELA	
50	901804 00000	TORNILLO TERMINAL DE ÁRBOL TUFLOK	
61	004803 27600	TAPA DE FILTRO	
67	009000 16300	MUELLE DE PRESIÓN	
72	909505 00000	<b>CARTUCHO DE FILTRO (1x)<sup>1)</sup></b>	
76	945373 00000	TORNILLO HEXAGONAL INTERIOR	
77	948021 00000	ANILLO DE JUNTA	
78	913161 00000	JUNTA TÓRICA	
83	006801 27500	CAPERUZA DE APARATO (INDEX <b>A</b> )	
83	006805 27500	CAPERUZA DE APARATO (INDEX <b>B</b> )	
85	951920 00000	PIEZA DE ORMA DE GOMA	
88	006802 27600	CAPERUZA DE APARATO	
89	741365 00000	AMORTIGUADOR DE GOMA	
90	945318 00000	TORNILLO HEXAGONAL INTERIOR	
91	951922 00000	PIEZA DE ORMA DE GOMA	
92	964110 00000	PROTECCIÓN DE CANTOS	
94	015100 27600	PIE	
95	951921 00000	PIEZA DE ORMA DE GOMA	
96	068000 27600	PIEZA DISTANCIADORA	
97	945328 00000	TORNILLO HEXAGONAL INTERIOR	
98	949451 00000	ARANDELA	
101	833903 99597	PLATILLO DE VÁLVULA	
102	951906 00000	BOQUILLA DE CABLE	
103	068002 16500	TUBO DISTANCIADOR	
104	548800 16300	TORNILLO DE CÁNCAMO	
124	736001 99613	VÁLVULA REGULADORA DE VACÍO	
127	727502 06000	VÁLVULA DE BARRIDO	

<sup>1)</sup> cantidad necesario / mantenimiento

VT 4.25 (1~) Versión - AC monofásica

VT 4.25/0-06 (3~) Versión sin filtro / AC trifásica

Para posiciones que derivan del aparato standard véase apéndice (lado trasero del plano)

OPCIONAL



VT 4.40

Pos.	No. De pedido	Descripción	
15	020000 16500	ÉMBOLO	
16	016800 16500	ARANDELA TENSORA	
17	911008 00000	ANILLO DE TOLERANCIA STAR	
18	949203 00000	POLEA DENTADA	
19	945320 00000	TORNILLO HEXAGONAL INTERIOR	
21	000102 16500	CARCASA	
23	945322 00000	TORNILLO HEXAGONAL INTERIOR	
24	901352 00007	<b>EMPUJADOR DE CARBÓN (KIT)<sup>1)</sup></b>	
25	952009 00000	CASQUILLO TENSOR	
28	000710 16500	TAPA LATERAL	
29	945374 00000	TORNILLO HEXAGONAL INTERIOR	
30	008900 16500	JUNTA	
46	902300 26200	VENTILADOR CON CUBO	
48	947713 00000	LENGÜETA DE AJUSTE	
49	949454 00000	ARANDELA	
50	901804 00000	TORNILLO TERMINAL DE ÁRBOL TUFLOK	
61	004803 27600	TAPA DE FILTRO	
67	009000 16300	MUELLE DE PRESIÓN	
72	909505 00000	<b>CARTUCHO DE FILTRO (1x)<sup>1)</sup></b>	
76	945373 00000	TORNILLO HEXAGONAL INTERIOR	
77	948021 00000	ANILLO DE JUNTA	
78	913161 00000	JUNTA ATÓRICA	
83	006801 27600	CAPERUZA DE APARATO	
85	951920 00000	PIEZA DE ORMA DE GOMA	
88	006802 27600	CAPERUZA DE APARATO	
89	741365 00000	AMORTIGUADOR DE GOMA	
90	945318 00000	TORNILLO HEXAGONAL INTERIOR	
91	951922 00000	PIEZA DE ORMA DE GOMA	
92	964109 00000	PROTECCIÓN DE CANTOS	
94	015100 27600	PIE	
95	951921 00000	PIEZA DE ORMA DE GOMA	
96	068000 27600	PIEZA DISTANCIADORA	
97	945328 00000	TORNILLO HEXAGONAL INTERIOR	
98	949451 00000	ARANDELA	
101	833903 99597	PLATILLO DE VÁLVULA	
102	951906 00000	BOQUILLA DE CABLE	
103	068002 16500	TUBO DISTANCIADOR	
104	548800 16300	TORNILLO DE CÁNCAMO	
124	736001 99613	VÁLVULA REGULADORA DE VACÍO	
127	727502 06000	VÁLVULA DE BARRIDO	

<sup>1)</sup> cantidad necesario / mantenimiento

VT 4.40 (1~) Versión - AC monofásica

Para posiciones que derivan del aparato standard véase apéndice (lado trasero del plano)

OPCIONAL



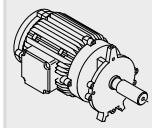

SERVICE ?

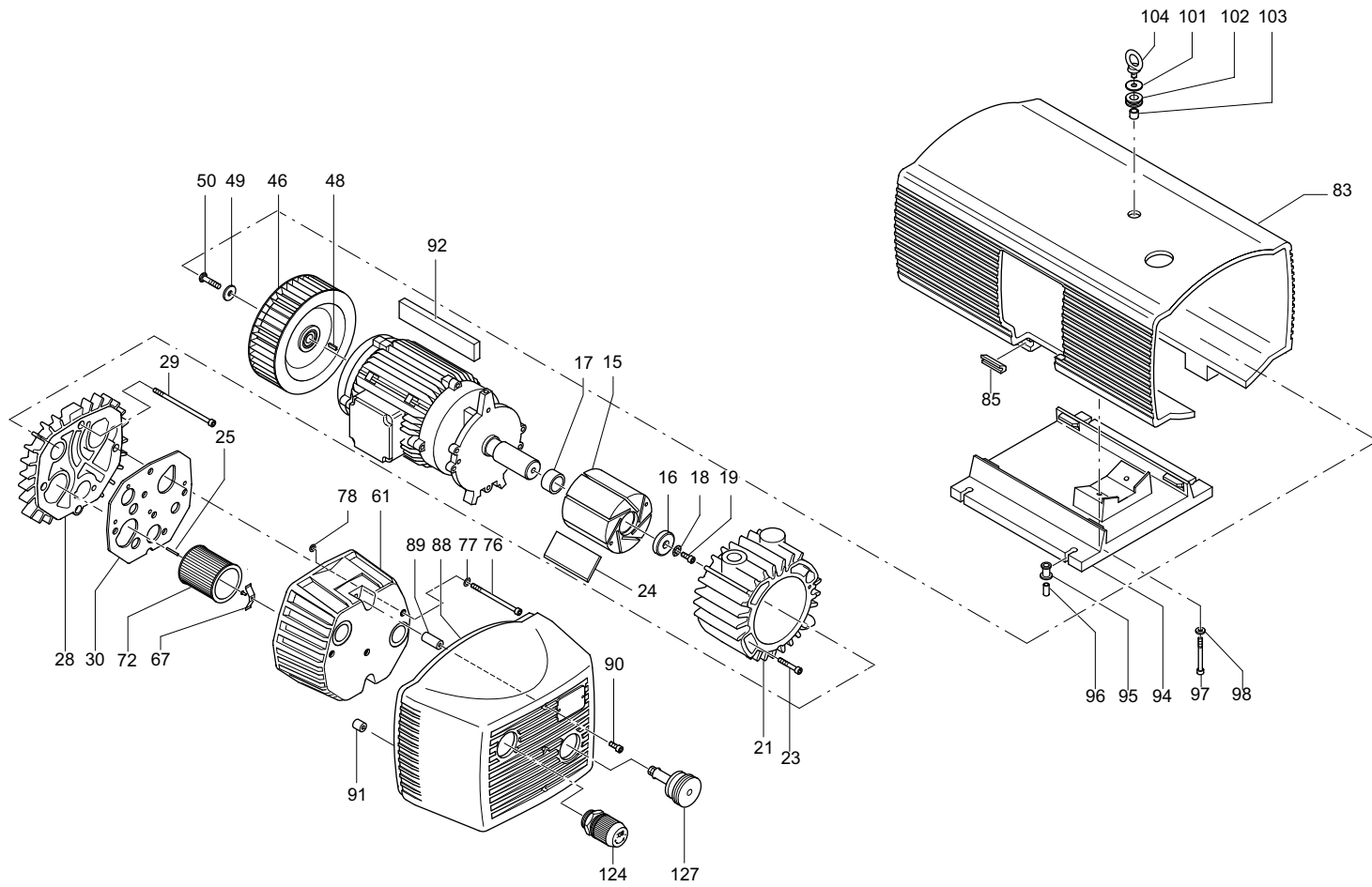
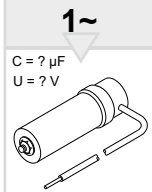
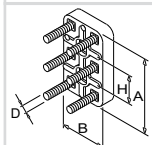
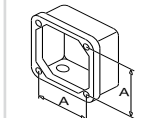
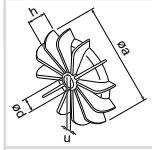



standard

**VT 4.25 (3~)**  
- Index A+B

**VT 4.40 (3~)**  
- Index A

optional  
en option  
optionale  
opcional

optional en option optionale opcional 	Variante(n) Modifications Variantes	Pos <sup>2)</sup>	Bestell Nr. / Ident No. / No. Identification / No. Identificazione / No. De pedido		Beschreibung / Description / Designation / Designazione / Descripcion
					
<b>VT 4.25 (1~)</b> - Index A+B  <b>VT 4.25/0-06 (3~)</b>  <b>VT 4.40 (1~)</b> - Index A	VT 4.25 (1~)	8	964233 00000		WINKEL / BRACKET / COUDES / GOMITO / ÁNGULO
	VT 4.40 (1~)	12	948766 00000		BLINDNIET / BLIND RIVET / RIVET AVEUGLIE / RIVETTO CIECO / REMACHE CIEGO
		13	742002 30000		KABEL / CABLE / CABLE / CAVO / CABLE
		83	006803 27500	006804-27500	<b>VT 4.25 (INDEX A)</b> - HAUBE / PROTECTING HOOD / CARTER PROTECTEUR / CARTER DI PROTEZIONE / CAPERUZA
		83	006806 27500	006805-27500	<b>VT 4.25 (INDEX B)</b> - HAUBE / PROTECTING HOOD / CARTER PROTECTEUR / CARTER DI PROTEZIONE / CAPERUZA
		83	006805 27600	006804-27600	<b>VT 4.40</b> - HAUBE / PROTECTING HOOD / CARTER PROTECTEUR / CARTER DI PROTEZIONE / CAPERUZA
		94	015101 27600	015100-27600	FUSS / FOOT / PIED / PIEDE / PIE
	VT 4.25/0-06 (3~)	21	000100 16400	000101-16400	GEHÄUSE / PUMP BODY / CORP DE POMPE / CARCASSA / CARCASA
		28	000707 16500	000710-16500	SEITENDECKEL / LID / COUVERCLE / COPERCHIO / TAPA LATERAL
		30		008900-16500	DICHTUNG / GASKET / JOINT / GUARNIZIONE / JUNTA
		61		004803-27600	FILTERDECKEL / FILTER COVER / COUVERCLE DU FILTRE / COPERCHIO FILTRO / TAPA DE FILTRO
		67		009000-16300	ANPRESSFEDER / LEAF SPRING / RESSORT-JAME / MOLLA / MUELLE DE PRESIÓN
		72		909505-00000	FILTERPATRONE / FILTER CARTRIDGE / CARTOUCHE FILTRANTE / CARTUCCIA FILTRO / CARTUCHO DE FILTRO
		77		948021-00000	DICHTRING / SEALING RING / JOINT / ANELLO GUARNIZIONE / ANILLO DE JUNTA
		78		913161-00000	O-RING / O-RING / ANNEAU-O / ANELLO-O / JUNTA TÓRICA
		83	006809 27500	006805-27500	HAUBE / PROTECTING HOOD / CARTER PROTECTEUR / CARTER DI PROTEZIONE / CAPERUZA
		88		006802-27600	GERÄTEHAUBE / PROTECTING HOOD / CARTER PROTECTEUR / CARTER DI PROTEZIONE / CAPERUZA
		89		741365-00000	GUMMIPUFFER / RUBBER BUFFER / AMORTISSEUR EN CAOUTCHOUC / AMMORTIZZATORE IN GOMMA / AMORTIGUADOR DE GOMA
		90		945318-00000	INNENSECHSKANTSCHRAUBE / SOCKET HEAD SCREW / VIS HEXAGONALE INTERNE / VITE ESAGONALE INTERNA / TORNILLO HEXAGONAL INTERIOR
	91		951022-00000	GUMMIFORMTEIL / RUBBER ELEMENT / ELEMENT EN CAOUTCHOUC / ELEMENTO IN GOMMA / PIEZA DE ORMA DE GOMA	

<sup>2)</sup> variantenabhängige Bauteile / variant-dependent components / composants variante-dependantes / componenti variante-dispendenti / componentes variante-dependientes